MTA-3101

10" Rugged Android™ Tablet Device

User's Manual

Version 1.1



2022.07

This page is intentionally left blank.

Revision History

| Version | Release Time | Description |
|---------|--------------|------------------------|
| 1.0 | 2022.05 | Initial release |
| 1.1 | 2002.07 | Revise CPU description |

Copyright Notice

All Rights Reserved.

The information in this document is subject to change without prior notice in order to improve the reliability, design and function. It does not represent a commitment on the part of the manufacturer.

Under no circumstances will the manufacturer be liable for any direct, indirect, special, incidental, or consequential damages arising from the use or inability to use the product or documentation, even if advised of the possibility of such damages.

This document contains proprietary information protected by copyright. All rights are reserved. No part of this manual may be reproduced by any mechanical, electronic, or other means in any form without prior written permission of the manufacturer.

Disclaimer

The information in this document is subject to change without prior notice in order to improve the reliability, design and function. It does not represent a commitment on the part of the manufacturer.

Under no circumstances will the manufacturer be liable for any direct, indirect, special, incidental, or consequential damages arising from the use or inability to use the product or documentation, even if advised of the possibility of such damages.

About This Manual

This user's manual provides the general information and installation instructions for the product. The manual is meant for the experienced users and integrators with hardware knowledge of personal computers. If you are not sure about any description in this manual, consult your vendor before further handling.

We recommend that you keep one copy of this manual for the quick reference for any necessary maintenance in the future. Thank you for choosing Midas Touch's products.

Contents

| | |
|---|-----------|
| Preface | v |
| Declaration of Conformity | v |
| CE | v |
| FCC Class B | v |
| RoHS | vi |
| SVHC / REACH | vi |
| FCC Warning | vii |
| Safety Symbols | viii |
| Important Safety Instructions..... | viii |
| Laser Safety | x |
| Rechargeable Battery Pack Safety | x |
| General Cleaning Tips | xii |
| Cleaning Tools..... | xii |
| Recommended Cleaning Procedures..... | 1 |
| Disposing of the Equipment | 1 |
| Additional Information & Technical Support..... | 2 |
| Warranty | 2 |
| | |
| Chapter 1 Introduction | 3 |
| 1.1 Product Highlights..... | 4 |
| 1.2 Package Contents..... | 4 |
| 1.3 Optional Accessories..... | 5 |
| 1.4 Parts of the Device..... | 6 |
| 1.5 Specifications..... | 7 |
| | |
| Chapter 2 Installation | 9 |
| 2.1 Installing microSD and SIM Card | 10 |
| 2.2 Charging the Battery | 10 |
| 2.2.1 Charging the Battery | 11 |
| 2.2.2 Checking the Battery Level | 11 |
| 2.3 Installing/Replacing the Battery..... | 12 |
| 2.3.1 Accessing Battery Chamber..... | 12 |
| | |
| Chapter 3 Using the Device | 15 |
| 3.1 Using Touch Screen | 16 |
| 3.1.1 Basic Operations..... | 16 |
| 3.1.2 Text Input | 16 |
| 3.1.3 Sleep Mode..... | 17 |
| 3.2 Home Screen | 18 |

- 3.2.1 Using the Quick Settings Panel..... 20
- 3.2.2 Enabling/Disabling Screen Rotation..... 20
- 3.2.3 Enabling/Disabling Screen Rotation..... 21
- 3.3 Configurations.....21
 - 3.3.1 Configuring Your SIM Card.....22
 - 3.3.2 Making/Receiving Calls 23
 - 3.3.3 Data Connection 23
- 3.4 Using the Wi-Fi Feature 24
 - 3.4.1 Enabling Wi-Fi and Connecting to a WLAN..... 25
 - 3.4.2 Adding a Wi-Fi Network..... 25
 - 3.4.3 Forgetting/Modifying a Wi-Fi Network 26
 - 3.4.4 Making Your Device a Wi-Fi Hotspot.....27
- 3.5 Enabling Bluetooth and Pairing with Bluetooth Device 28
 - 3.5.1 Configuring Bluetooth Features to Use.....29
 - 3.5.2 Disconnect from a Bluetooth Device 30
 - 3.5.3 Additional Bluetooth Settings 30
- 3.6 Using the Location Feature 31
 - 3.6.1 Enabling/Disabling Location Service 31
 - 3.6.2 Enabling/Disabling Location Service 31
- 3.7 Using Camera 32
- 3.8 Using the NFC Feature 34
 - 3.8.1 Enabling/Disabling NFC..... 34
- 3.9 Using the Barcode Scanner 35
 - 3.9.1 Scanning the Barcode..... 35
 - 3.9.2 Supported Barcode Formats..... 36

Declaration of Conformity

CE

The CE symbol on your product indicates that it is in compliance with the directives of the Union European (EU). A Certificate of Compliance is available by contacting Technical Support.

This product has passed the CE test for environmental specifications when shielded cables are used for external wiring. We recommend the use of shielded cables. This kind of cable is available from Midas Touch. Please contact your local supplier for ordering information.

FCC Class B

This device complies with Part 15 of the FCC Rules. Operation is subject to the following two conditions:

1. This device may not cause harmful interference
2. This device must accept any interference received, including interference that may cause undesired operation.

Any changes or modifications not expressly approved by the guarantee of this device could void the user's authority to operate the equipment.

This equipment has been tested and found to comply with the limits for a Class B digital device, pursuant to Part 15 of the FCC Rules. These limits are designed to provide reasonable protection against harmful interference in a residential installation. This equipment generates, uses and can radiate radio frequency energy and, if not installed and used in accordance with the instructions, may cause harmful interference to radio communications.

However, there is no guarantee that interference will not occur in a particular installation. If this equipment does cause harmful interference to radio or television reception, which can be determined by turning the equipment off and on, the user is encouraged to try to correct the interference by one or more of the following measures:

- Reorient or relocate the receiving antenna.
- Increase the separation between the equipment and receiver.

- Connect the equipment into an outlet on a circuit different from that to which the receiver is connected.
- Consult the dealer or an experienced radio/TV technician for help.

RoHS

Midas Touch certifies that all components in its products are in compliance and conform to the European Union's Restriction of Use of Hazardous Substances in Electrical and Electronic Equipment (RoHS) Directive 2002/95/EC.

The above mentioned directive was published on 2/13/2003. The main purpose of the directive is to prohibit the use of lead, mercury, cadmium, hexavalent chromium, polybrominated biphenyls (PBB), and polybrominated diphenyl ethers (PBDE) in electrical and electronic products. Member states of the EU are to enforce by 7/1/2006.

Midas Touch hereby states that the listed products do not contain unintentional additions of lead, mercury, hex chrome, PBB or PBDB that exceed a maximum concentration value of 0.1% by weight or for cadmium exceed 0.01% by weight, per homogenous material. Homogenous material is defined as a substance or mixture of substances with uniform composition (such as solders, resins, plating, etc.). Lead-free solder is used for all terminations (Sn(96-96.5%), Ag(3.0-3.5%) and Cu(0.5%)).

SVHC / REACH

To minimize the environmental impact and take more responsibility to the earth we live, Midas Touch hereby confirms all products comply with the restriction of SVHC (Substances of Very High Concern) in (EC) 1907/2006 (REACH -- Registration, Evaluation, Authorization, and Restriction of Chemicals) regulated by the European Union.

All substances listed in SVHC < 0.1 % by weight (1000 ppm)

FCC Warning

This device complies with part 15 of the FCC Rules. Operation is subject to the following two conditions: (1) This device may not cause harmful interference, and (2) this device must accept any interference received, including interference that may cause undesired operation.

Any Changes or modifications not expressly approved by the party responsible for compliance could void the user's authority to operate the equipment.

This equipment has been tested and found to comply with the limits for a Class B digital device, pursuant to part 15 of the FCC Rules. These limits are designed to provide reasonable protection against harmful interference in a residential installation. This equipment generates uses and can radiate radio frequency energy and, if not installed and used in accordance with the instructions, may cause harmful interference to radio communications. However, there is no guarantee that interference will not occur in a particular installation. If this equipment does cause harmful interference to radio or television reception, which can be determined by turning the equipment off and on, the user is encouraged to try to correct the interference by one or more of the following measures:

- -Reorient or relocate the receiving antenna.
- -Increase the separation between the equipment and receiver.
- -Connect the equipment into an outlet on a circuit different from that to which the receiver is connected.
- -Consult the dealer or an experienced radio/TV technician for help.

The SAR limit of USA (FCC) is 1.6 W/kg averaged over one gram of tissue.

Device types U7 Plus (FCC ID: 2ANMU-U7PLUS) has also been tested against this SAR limit. The highest reported SAR values for head, body-worn accessory are 0.75 W/kg, 0.79 W/kg respectively. The Max simultaneous SAR is 1.01 W/kg. This device was tested for typical body-worn operations with the back of the handset kept 10mm from the body. To maintain compliance with FCC RF exposure requirements, use accessories that maintain a 10mm separation distance between the user's body and the back of the handset. The use of belt

clips, holsters and similar accessories should not contain metallic components in its assembly. The use of accessories that do not satisfy these requirements may not comply with FCC RF exposure requirements, and should be avoided.

The antenna(s) used for this transmitter must not be co-located or operating in conjunction with any other antenna or transmitter.

Safety Symbols



This symbol of “CAUTION” indicates that there is a danger of injury to the user or a risk of damage to the product, should warning notices be disregarded.



This symbol indicates electrical warning.

Important Safety Instructions

Read these safety instructions carefully:

1. Read all cautions and warnings on the equipment.
2. Place this equipment on a reliable surface when installing. Dropping it or letting it fall may cause damage.
3. Make sure the correct voltage is connected to the equipment.
4. For pluggable equipment, the socket outlet should be near the equipment and should be easily accessible.
5. Keep this equipment away from humidity.
6. Disconnect this equipment from the A/C outlet before cleaning it. Use a moist cloth. Do not use liquid or sprayed detergent for cleaning.
7. To fully disengage the power to the unit, please disconnect the power from the AC outlet.
8. Do not scratch or rub the screen with a hard object.
9. Never use any of the solvents, such as Thinner Spray-type cleaner, Wax, Benzene, Abrasive cleaner, Acid or Alkaline solvent, on the display. Harsh chemicals may cause damage to the cabinet and the touch sensor.

10. Remove dirt with a lightly moistened cloth and a mild solvent detergent. Then wipe the cabinet with a soft dry cloth.
11. The openings on the enclosure are for air convection and protect the equipment from overheating. **DO NOT COVER THE OPENINGS.**
12. Position the power cord so that people cannot step on it. Do not place anything over the power cord.
13. If the equipment will not be used for a long time, disconnect it from the power source to avoid damage by transient overvoltage.
14. Never pour any liquid into openings. This may cause fire or electrical shock.
15. Never open the equipment. For safety reasons, the equipment should be opened only by qualified service personnel.
16. If one of the following situations arises, get the equipment checked by service personnel:
 - a. The power cord or plug is damaged.
 - b. Liquid has penetrated into the equipment.
 - c. The equipment has been exposed to moisture.
 - d. The equipment does not work well, or you cannot get it to work according to the user's manual.
 - e. The equipment has been dropped or damaged.
 - f. The equipment has obvious signs of breakage.
17. The sound pressure level at the operator's position, according to IEC 704-1:1982, is no more than 70dB(A).
18. Keep this User's Manual for later reference.
19. **DO NOT LEAVE THIS EQUIPMENT IN AN UNCONTROLLED ENVIRONMENT WHERE THE STORAGE TEMPERATURE IS BELOW -20° C (-4° F) OR ABOVE 85° C (185° F). THIS MAY DAMAGE THE EQUIPMENT.**



Do not use the power adapter that isn't made for the equipment. Supplying the equipment with inappropriate voltage may cause harm to or burn the equipment.



To prevent possible hearing damage, do not listen at high volume levels for long periods

Laser Safety

The device's barcode scanner that uses laser lights is a class 2 laser product. **DONOT** stare into the laser beams or point the laser beam at any one's eyes when the barcode scanner is in operation.



Rechargeable Battery Pack Safety

With very little care, you can optimize the battery life and maximize the lifespan of the battery. Most importantly, use only the equipment in its ideal operating temperature (as described in 1.5 Specifications) – do not leave it in a hot trunk during the summer.

- **Important Terms to Understand**

“Battery life” means the time the equipment will run before it must be recharged (sometimes this is also called “playtime” or “runtime”).

“Battery lifespan” means the total amount of time your battery will last before it must be replaced.

- **Using the Equipment for the First Time**

Be sure to fully charge (approx. 4 hours) the equipment when charging the equipment for the first time.

- **Long-Term Storage & Maintenance**

If you are putting away the battery for more than three months, it is recommended that the battery should be stored separately and fully charged, and get recharged every three months. If you store an uncharged battery, it could fall into a deep worn-out state which would render it incapable of holding any charge. Be sure to store the equipment and battery at the proper temperature (as described in 1.5 Specifications).

- **Battery Lifespan**

The removable batteries for the equipment are designed to retain up to 80% of their original capacity after 300 charging and recharging cycles when properly maintained. You may choose to purchase new battery when it no longer holds the sufficient charge that meets your needs.

- The lithium-ion battery is currently one of the most popular battery packs. The best advantage is that it has no memory effect, so users needn't worry about that issue. Users can charge the battery anytime whether it is fully drained or not. However, it's recommended that users drain the battery until the system shows power shortage warning and then recharge the battery. Doing so is helpful to the reliability of your battery.
- Don't use the battery pack as a power supply for other equipment.
- Don't expose the battery to elevated heat situations such as under direct sunlight in a car or near fire.
- Don't disassemble the battery, or the battery leakage might cause skin or eye injury. If electrolyte leaking from the battery contacts your skin or clothing, immediately flush it with running water. If it splashes into eye, rinse the eye at least 15 minutes with clean water and then seek medical attention.
- To avoid battery leakage or explosion, don't discard the battery into water or fire, or put them near a heat source such as a gas to oven.
- If you are putting away the battery for more than three months, it is recommended that the battery should be stored separately and fully charged, and get recharged every three months. If you store an uncharged battery, it could fall into a deep worn-out state which would render it incapable of

holding any charge. Be sure to store yourthe equipment and battery at the proper temperature (as described in [1.5 Specifications](#) on page 7).

- Use the appropriate container to store the battery such as a paper box. Do not allow a metal object to touch the terminal of the battery.
- The battery consists of precise electrical components and cells. Do not drop or hit the battery.

General Cleaning Tips

You may need the following precautions before you begin to clean the device. When you clean any single part or component for the device, please thoroughly read and understand the details below.

1. We strongly recommended that you should shut down the system before you start to clean any single components.
2. When you need to clean the device, please rub it with a piece of dry cloth.
3. Be cautious of the tiny removable components when you use a vacuum cleaner to absorb the dirt on the floor.
4. Never drop the components inside the device or get circuit board damp or wet.
5. Be cautious of all kinds of cleaning solvents or chemicals when you use it for the sake of cleaning. Some individuals may be allergic to the ingredients.
6. Try not to put any food, drink or cigarette around the device.

Cleaning Tools

Although many companies have created products to help improve the process of cleaning your devices and peripherals, users can also use household items to clean their devices and peripherals. Below is a listing of items you may need or want to use while cleaning your devices or peripherals. Keep in mind that some components in your device may only be able to be cleaned using a product designed for cleaning that component, if this is the case it will be mentioned in the cleaning.

- **Cloth:** A piece of cloth is the best tool to use when rubbing up a component. Although paper towels or tissues can be used on most hardware as well, we still recommend you to rub it with a piece of cloth.

-
- **Water or rubbing alcohol:** You may moisten a piece of cloth a bit with some water or rubbing alcohol and rub it on the device. Unknown solvents may be harmful to the plastics parts.
 - **Vacuum cleaner:** Absorb the dust, dirt, hair, cigarette particles, and other particles out of the device can be one of the best cleaning methods. Over time, these items can restrict the airflow in a device and cause circuitry to corrode.
 - **Cotton swabs:** Cotton swabs moistened with rubbing alcohol or water are excellent tools for wiping hard to reach areas in your keyboard, mouse, and other locations.
 - **Foam swabs:** Whenever possible, it is better to use lint-free swabs such as foam swabs.

Recommended Cleaning Procedures

1. Close all application programs
2. Close operating software
3. Turn off the equipment
4. Remove all peripherals
5. Disconnect the power cable
6. Proceed to clean.

Disposing of the Equipment

- **Within the European Union**



EU-wide legislation, as implemented in each Member State, requires that waste electrical and electronic products carrying the mark (left) must be disposed of separately from normal household waste.

This includes monitors and electrical accessories, such as signal cables or power cords. When you need to dispose of your display products, please follow the guidance of your local authority, or ask the shop where you purchased the product, or if applicable, follow any agreements made between yourself. The mark on electrical and electronic products only applies to the current European Union Member States.

- **Outside the European Union**

If you wish to dispose of used electrical and electronic products outside the European Union, please contact your local authority so as to comply with the correct disposal method.

Additional Information & Technical Support

You can download the related technical documents such as datasheet and user's manual as well as driver on our website.

Please do not hesitate to call or e-mail our customer service when you still cannot get the information you need.

E-mail:

contact@midastouchinc.com

Warranty

This product is warranted to be in good working order during the warranty period. Should this product fail to be in good working order at any time during this period, we will, at our option, replace or repair it at no additional charge except as set forth in the following terms. This warranty does not apply to products damaged by misuse, modifications, accident or disaster.

Vendor assumes no liability for any damages, lost profits, lost savings or any other incidental or consequential damage resulting from the use, misuse of, or inability to use this product. Vendor will not be liable for any claim made by any other related party.

Vendors disclaim all other warranties, either expressed or implied, including but not limited to implied warranties of merchantability and fitness for a particular purpose, with respect to the hardware, the accompanying product's manual(s) and written materials, and any accompanying hardware. This limited warranty gives you specific legal rights.

Return authorization must be obtained from the vendor before returned merchandise will be accepted. Authorization can be obtained by calling or faxing the vendor and requesting a Return Merchandise Authorization (RMA) number. Returned goods should always be accompanied by a clear problem description.

Chapter 1

Introduction

1.1 Product Highlights

- 10.1" IPS TFT LCD 1200*1920(FHD)
- Embedded 1D/2D barcode imager and 8M front camera and 13M rear camera
- High mobility with multiple-connectivity including WLAN, BT and WWAN
- Extremely thinnest industrial tablet under 15mm
- Removable 10000mAh battery
- Hot-swappable battery system provides 24/7 mobile computing
- 1m (3.3ft.) drop resistance
- Fully rugged IP65 to protect from dust and water
- Support Android 11 base

1.2 Package Contents

Upon opening the package, carefully inspect the contents. If any of the items is missing or appears damaged, contact your local dealer or distributor. The package should contain the following items:



MTA-3101 10.1" Rugged Android Tablet

| | |
|-----------------|--------------------------------|
| Lithium Battery | 1 x Lithium Battery (10000mAh) |
|-----------------|--------------------------------|

| | |
|---------|-------------------------|
| Antenna | Wi-Fi/Bluetooth Antenna |
|---------|-------------------------|

| | |
|-------------|---------------------------------|
| USB Charger | 1 x Charger (5V/2A or 9V/2A) |
|-------------|---------------------------------|



1 x Type C USB Cable(1M)



1 x Quick Start Guide

1.3 Optional Accessories

| | |
|------------------|---|
| Power Adapter | AC/DC Power Adapter w/ 2-pin power terminal |
| Cradle(Standard) | Charging cradle with USB Type-C port |
| Cradle(High) | Charging cradle with 1 x RS232 port, 1 x USB Type-A port, 1 x USB Type-B port 1 x RJ45 port |
| Hand Strap | Black, 220 x 123mm, come with screws |

1.4 Parts of the Device

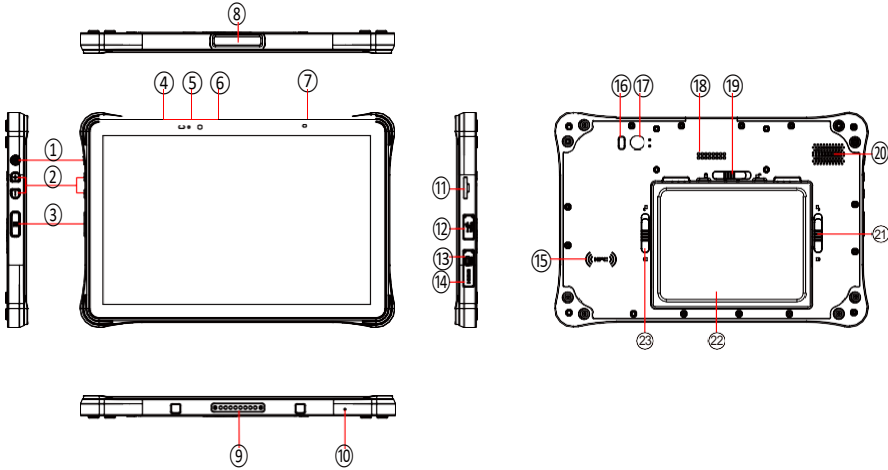

| | | | |
|----|--------------------|----|--------------------|
| 1 | Power Button | 13 | USB Type-C |
| 2 | Volume Button | 14 | Micro HDMI |
| 3 | Scan Key | 15 | NFC |
| 4 | Light sensor | 16 | LED Flash |
| 5 | Charging LED | 17 | Rear Camera |
| 6 | Front Camera | 18 | POGOPIN |
| 7 | Scan LED | 19 | Battery Cover Lock |
| 8 | Barcode Scanner | 20 | Speaker |
| 9 | POGOPIN | 21 | Battery Cover Lock |
| 10 | MIC | 22 | Battery |
| 11 | TF/ NANO SIM Slots | 23 | Battery Cover Lock |
| 12 | USB Type-A | | |

1.5 Specifications

| | |
|--------------------------------|---|
| System | |
| CPU | MediaTek MT8788 (4x Cortex A73 2.0GHz / 4x Cortex A53 2.0GHz) |
| OS | Android™ 11 |
| Memory | 4GB/6GB (LPDDR 4X) |
| Flash | 64GB/128GB |
| Peripherals and Devices | |
| Camera | Front: 8M (Default) Rear: 13M(Default)/21M(Optional) with Flashlight |
| Sensor | Accelerometer (G-sensor) Magnetometer Gyroscope Barometer (optional) Ambient light sensor |
| Navigation | AGPS/GPS/Glonass/Beidou/Galileo |
| Barcode Scanner | Honeywell 6603 |
| Audio & Vibrator | 2 x built-in microphone 1 x built-in speaker (2W) 1 x vibrator |
| OTG | Support |
| PTT(Push To Talk) | Support |
| Wireless | |
| WLAN | 2.4G, 5G (Dual bend) |
| Bluetooth | BT 4.2 |
| WWAN | 2G: GSM/GPRS: 850/900/1800/1900 MHz 3G:WCDMA: B1/B2/B5/B8 4G:LTE Bands 1/2/3/4/5/7/8/12/17/19/20/28A/2B/34/38/39/40/41 |
| NFC | Support (ISO/IEC14443A/B; ISO/IEC15693; Tags T1/2/3/4/5; etc.) |
| I/O Interface | |
| SD Slot | 1 x microSD card slot (max 512GB) |

| | |
|---|---|
| HDMI | 1 x Micro HDMI |
| SIM Socket | Mode 1: 2 x Nano SIM card Mode 2: 1 x Nano SIM card, 1 x micro SD card |
| USB Port | 1 x USB Type-A, 1 x USB Type-C |
| Qualification | |
| Certification | CE, FCC, NCC |
| Durability Features | |
| IP-65 certified 1m (3.3ft.) drop-resistance (with rubber tube) | |
| Power Supply | |
| Charging | USB Type-C, Pogo pin (Fast Charging) |
| Power input | 9V/2A(fast charging) or 5V/2A |
| Battery capacity | 1 x Hot swappable 3.8V 10000mAh 1 x 1000mAh internal battery pack |
| Key | |
| Physical Buttons | Volume, Barcode Trigger, Power Button |
| Mechanical & Environmental | |
| Operating Temp. | -10°C ~ 50°C |
| Storage Temp. | -30°C ~ 70°C |
| ESD | ±15kV aerial discharge, ±8kV direct contact discharge |
| Relative Humidity | 10% ~ 90%RH |
| Dimension | W: 246.1*H: 164.2*D:14.9mm |
| Weight | 890g |



Chapter 2

Getting Started

2.1 Installing microSD and SIM Card

To install a microSD card and Nano SIM card to the device, locate the microSD and Nano SIM card holder on the side and insert the card following the direction as shown in the following figure. Push the card holder into the slot until it locks into place.

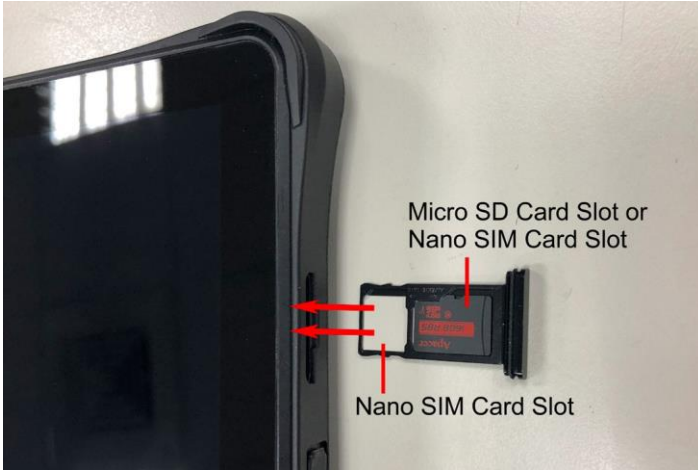

2.2 Charging the Battery

Due to shipment, the battery is partially drained when the package is delivered to you. Be sure to charge the battery to full when you are charging it for the first time.

2.2.1 Charging the Battery

To charge the battery Via a electrical outlet:

1. Using the TYPE-C USB cable that comes with the device, connect the small end of the cable to the USB TYPE-C port on the device.
2. Then connect the other end of the TYPE-C USB cable to the power adapter.
3. Connect the power adapter to an electrical outlet.

To charge the battery Via a Computer:

1. Using the TYPE-C USB cable that comes with the device, connect the small end of the cable to the USB TYPE-C port on the device.
2. Then connect the other end of the TYPE-C USB cable to a computer.

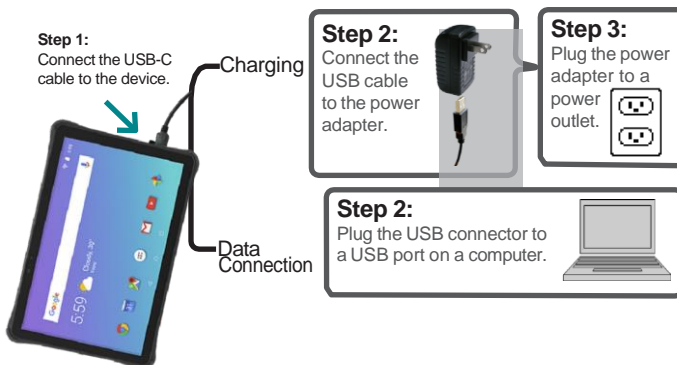

Warning: Use only the power adapter that comes with your device. Using a different power adapter may damage your device and may result in poor performance. It may also invalidate warranty applying to the device.

2.2.2 Checking the Battery Level

The battery indicator will appear in the status bar showing the charging percentage when the charging is in process. Unplug the USB cable from the device when the battery is fully charged.

2.3 Installing/Replacing the Battery

In case you need to install or replace the battery, follow the steps as below to access the battery chamber and replace the battery.

2.3.1 Accessing Battery Chamber

1. Place the device on a flat surface, facing up the rear side. Unlock the battery cover, then open the battery cover as the picture below.

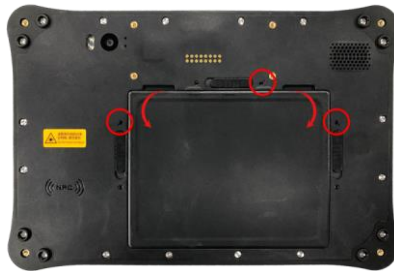
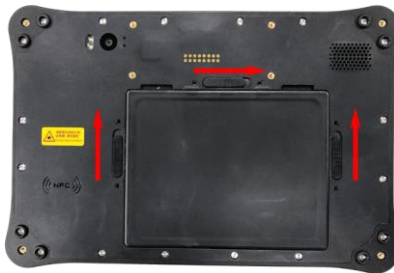

2. After the battery cap is opened, you can remove the battery and switch it.



3. Close the battery cap and lock it when the switching process is done.

This page is intentionally left blank.



Chapter 3

Using the Rugged Handheld Device

3.1 Using Touch Screen

MTA-3101 comes with a projected capacitive multi-touch screen. Touch control is the main way to interact with the MTA-3101. Users are able to manipulate icons, graphic buttons, menus, the onscreen keyboard or any onscreen items with touch control. This chapter will walk you through the basic operations.

3.1.1 Basic Operations

The table below provides instructions on how to use the multi-touch screen:

| Operation | Description |
|---------------|---|
| Tap | Tap an item and quickly release to select an item, launch an application, or open a menu. |
| Tap and hold | Tap and hold an item or a blank area on the screen for a few seconds until a menu opens or an option appears. |
| Drag | Tap and hold on an item, such as an image or an icon, then move it to the target position. While dragging, do not release until you have reached the target position. |
| Swipe | Move your finger horizontally or vertically across the screen to scroll through the screen, App menu, pages, lists and so on. |
| Zoom in / out | Move two fingers closer together on an item, such as a picture, web page, or map, to zoom out, or move two fingers apart to zoom in. |
| Double Tap | For some applications, quickly tap twice on an item to zoom in and double-tap again to zoom out. |

3.1.2 Text Input

The MTA-3101 doesn't have a physical keyboard to receive user's text input. To input text on the device, it relies on the "onscreen keyboard" featured by the operating system. An "onscreen keyboard" is a virtual keyboard with most of the standard keys.

To open the onscreen keyboard, simply tap a text input field and the keyboard appears.

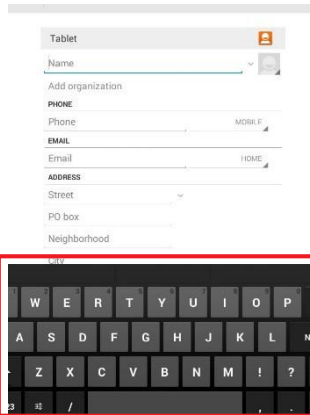

3.1.3 Sleep Mode

When the device suspends to sleep mode, it enters a low power state and the display is off to save the battery power. You can manually force the device to enter sleep mode or specify a period of inactivity before it automatically enters sleep mode. While the device is in sleep mode, it is still capable of receiving messages and calls and processing tasks like downloading.

To switch to sleep mode, press and hold the Power key until the screen is turned off.

To wake up the device from sleep mode, press and hold the Power key until the screen is turned on. If the screen is locked, swipe the screen and unlock the device.

To specify the period of inactivity, swipe down the Status Bar in the upper right corner and tap Settings | Display | Sleep timeout. Then select a time of inactivity before the device enters sleepmode.

3.2 Home Screen

The **Home** screen provides you with an instant access to device status, notifications, application shortcuts, folders and widgets. Simply tap an item and you can launch the associated application. You can also add desired items to the **Home** screen, extend the **Home** screen or personalize the wallpaper to tailor it to your personal needs.

When you power on the device for the first time, a typical **Home** screen looks like the example below.

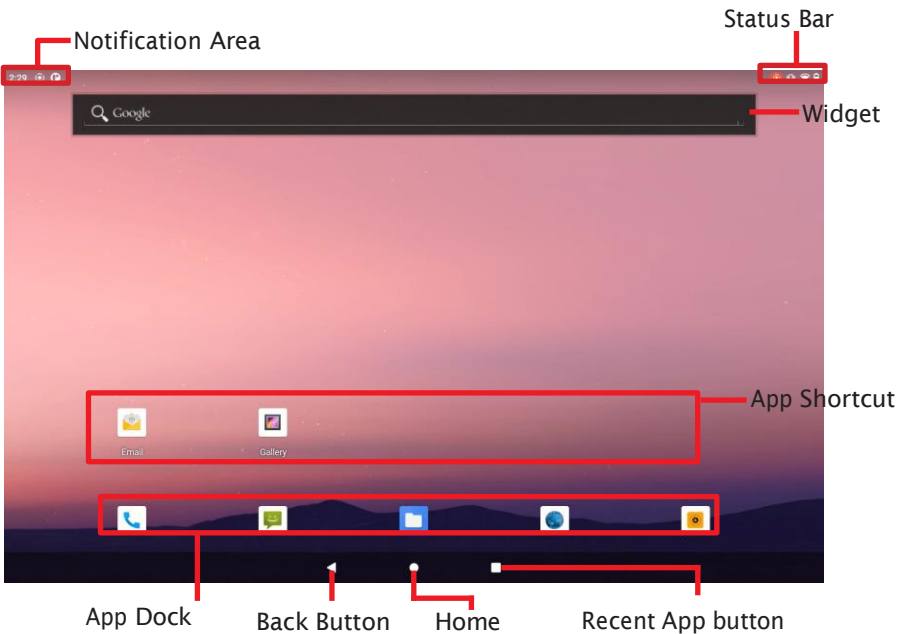

The table below describes the elements on a typical **Home** screen:

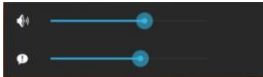
| Element | Descriptions |
|----------------------------|---|
| Home Screen | <ul style="list-style-type: none"> • Tap an item on this screen to launch that item. • To delete an icon or widget, tap and hold that item until the remove symbol X appears on the top of the screen. Then move the icon to the X symbol. • Tap and hold any empty spot on this screen to customize your home screen. |
| Status Bar | <p>The Status Bar displays the information such as the system time, Wi-Fi signal strength, Ethernet connection status and Bluetooth connection status.</p> <p>You can access the Quick Settings panel by swiping up the status bar.</p> |
| Notification Area | <p>The Notifications Area informs you of new messages, events, alarms, and activities in progress. Applications you install on your device may show their own icons or messages in the area.</p> <p>You can access the notification panel to see more information by swiping down the Notification Area.</p> |
| Widget | The miniature of an application that functions directly on the Home screen. |
| App Launcher | Tap it to open the " App Launcher " where all applications installed on the device can be viewed and launched. |
| App Dock | The dock is visible across the home screens. It shows the most commonly used App icons for quick access. You can change the icons as needed. |
| Back Button | Tap to go to the previous screen. |
| Home Button | Tap to return to Home scree. |
| Current Running App Button | Tap to view show your current running Apps and touch an App to open it. To remove an App from the list, swipe it left or right. |
| Volume Up/Down Button | <p>Tap to adjust the speaker volume. On the volume control panel tap the settings icon  to adjust the notifications volume.</p>  |

3.2.1 Using the Quick Settings Panel

Swiping down the **Status Bar** will bring up a **Quick Settings** panel where you can quickly access some most commonly used settings and features. To enable/disable a feature or switch between available options , simply tap the intended tile. It appears dimmed when disabled and brightened when enabled.

For some features such as Wi-Fi, Bluetooth, Location, Audio Profiles, you can also tap and hold the tile to directly access the settings page.

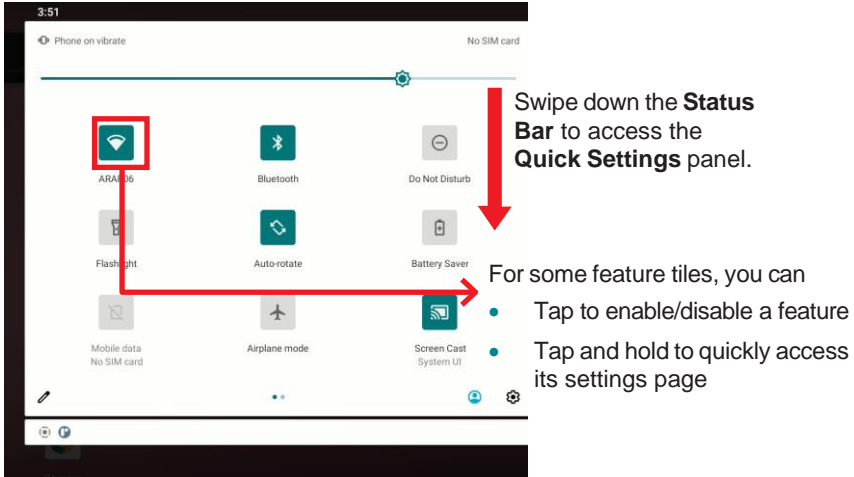

3.2.2 Enabling/Disabling Screen Rotation

The MTA-3101 automatically rotates the display when tilted sideways. You may enable or disable the auto rotation function as needed. To do so, swipe down the **Status bar** and tap the **AUTO ROTATE** tile to enable or disable the auto rotation function.

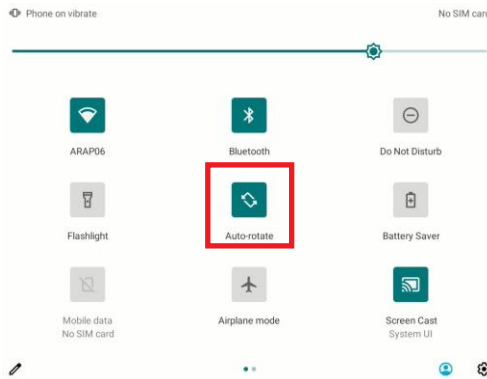

3.2.3 Enabling/Disabling Screen Rotation

The Home screen is extended beyond the screen width to provide more space for adding application shortcuts and widgets.

To access the extended Home screen, swipe on the Home screen to the left or right. To add application icons or widgets to the extended Home screen:

1. Tap the App Launcher icon on the Home screen to locate the target application icon or widget.
2. Tap and hold the target icon or widget until the extended Home Screen appears.
3. Move the icon or widget to desired screen and then release.

3.3 Configurations



To configure the settings of Ethernet, Wi-Fi, Bluetooth or other features, tap the **Setting** icon on the Home screen to open the **Settings** page and change relevant settings for your device if necessary.

3.3.1 Configuring Your SIM Card

After you insert the SIM card(s) to the MTA-3101 for the first time and power on the MTA-3101, depending on your mobile network carrier you might be guided to activate the account and connect to your mobile network. If you are asked for a PIN to unlock the SIM card when powering on the MTA-3101, contact your cellular network carrier for the default PIN.

When a new SIM card is detected by the MTA-3101, you will be prompted to configure its usage, including voice call, messaging and data connection. You can configure it now or change the settings later.

Featuring dual-SIM card slots, the MTA-3101 supports dual-SIM mobile connection, allowing you to enjoy constant and seamless Internet connection. Two cellular network icons will be displayed in the Status Bar to indicate the connectivity and signal strength.

| Icon | Descriptions |
|---|--|
|  | No signal or no SIM card inserted. |
|  | Connected to a cellular network. (The more bars are lit, the stronger the wireless signal is) |

Different locations may have different mobile networks available. The MTA-3101 adopts the fastest mobile network available for data. However, in order to extend the battery life, you can configure the MTA-3101 to use only a slower 2G network for data. You can also configure the MTA-3101 to access a different set of networks entirely, or to behave in special ways when roaming.

If there is no SIM card, the MTA-3101 isn't capable of 3G voice and data services; however it is still able to connect to a Wi-Fi network to log into a wireless local area network. To learn more [3.4 Using the Wi-Fi Feature](#) on page [24](#).

3.3.2 Making/Receiving Calls

After you activate your SIM card(s), the MTA-3101 auto-connects to your cellular network when it powers on. You can start to use the phone service.

Using phone service, e.g., making or answering a call, is similar to the way you use a mobile phone.

To use the device for phone service, it is suggested that you connect a wired headset to the device's headset connector or use a wireless Bluetooth headset or car kit. For instructions on how to connect to a Bluetooth device, see [3.5 Enabling Bluetooth and Pairing with Bluetooth Device](#) on page 28.

3.3.3 Data Connection

Connecting to a cellular network enables you to use voice service as well as data connection service, e.g., the Internet connection. However, in most cases using Wi-Fi for data connection is faster and less expensive than using a cellular network and you may want to disable data connection of your SIM card when Wi-Fi is available. On the other hand, you may want to enable cellular data connection when Wi-Fi is not available.

To enable or disable data connection:

1. Swipe down the **Status bar** and tap **Mobile data**.
1. Enable data connection for a desired SIM card or tap **Off** to disable data connection.

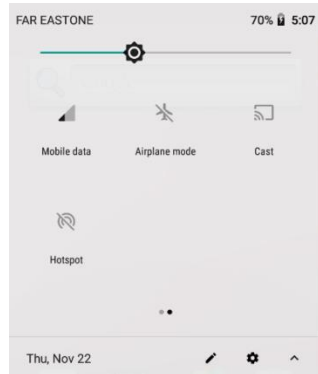

3.4 Using the Wi-Fi Feature

The MTA-3101 is capable of Wi-Fi networking. Wi-Fi is a wireless networking technology that uses an access point, also known as the “hotspot”, to connect to an Internet service provider over the wireless local area network (WLAN). Some hotspots are open to connect while others request you to present a key to authenticate your connection. The MTA-3101 needs to be configured including such key to connect to a hotspot.



Follow the guide below to connect the MTA-3101 to your wireless local area network:

Note: Turn off Wi-Fi when it isn't used to extend battery life.

Follow the guide below to connect the MTA-3101 to your wireless local area network:

Note: Turn off Wi-Fi when it isn't used to extend battery life.

The Status Bar displays the following icons that shows Wi-Fi status.

| Icon | Descriptions |
|---|---|
|  | Notifies that an open Wi-Fi network is in range. |
|  | Notifies that a Wi-Fi network is connected. Waves indicate signal strength. |

3.4.1 Enabling Wi-Fi and Connecting to a WLAN

To use the Wi-Fi feature, switch on the Wi-Fi function on the **Settings** page. Then tap a network to connect to it. To connect to a secured network, you will be prompted to enter a password or other credentials.

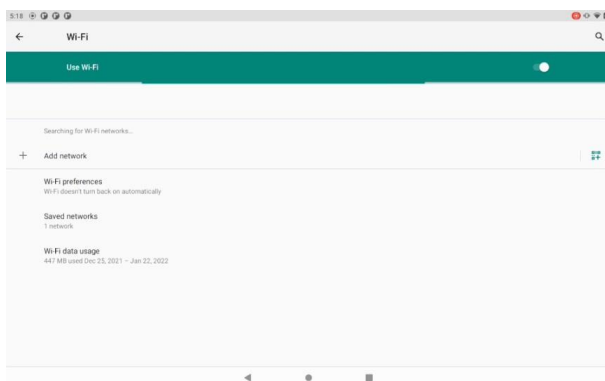

3.4.2 Adding a Wi-Fi Network

Under the following situations, you may need to manually add a Wi-Fi network:

- When a Wi-Fi network doesn't broadcast its name (SSID) Using the Rugged Handheld Device
- When a Wi-Fi network is out of range and you want the MTA-3101 to remember it and auto-connect to it as soon as it gets in range.

To add a Wi-Fi network:

1. Swipe down the Status bar and tap the WI-FI tile to enable Wi-Fi if it isn't enabled yet.
2. In the Quick Settings panel, tap and hold the WI-FI tile to access the Wi-Fi settings page.
3. Tap the plus sign icon in the upper right corner to open the Add network dialog box.

4. Enter the SSID(name) of the network. If the network is secured, tap the triangle at the right of the Security field to select the type of security deployed on the network and enter any required security credentials.
5. Tap **Save**.

The MTA-3101 then proceeds to connects to the Wi-Fi network. Any credentials entered are saved so the MTA-3101 automatically connects it the next time the MTA-3101 gets it within the range.

3.4.3 Forgetting/Modifying a Wi-Fi Network

When you don't want the MTA-3101 to "auto" connect to a Wi-Fi network or when it is a network that you no longer use, remove the Wi-Fi network by the steps below:

1. Swipe down the Status bar and tap the WI-FI tile to enable Wi-Fi if it isn't enabled yet.
2. In the Quick Settings panel, tap and hold the WI-FI tile to access the Wi-Fi settings page.
3. On the Wi-Fi settings screen, tap and hold the name of the network to forget.
4. Tap Forget network.

Some Wi-Fi networks may periodically change their passwords to enhance the network security. When this occurs, you need to change the saved login credentials. To change the password, follow the steps above to access the context menu of the intended network. Then tap Modify network to make the changes.

3.4.4 Making Your Device a Wi-Fi Hotspot

When the MTA-3101 is connected to a 4G network, you can share the connection with your laptop or other devices by making your MTA-3101 a Wi-Fi hotspot. To do so:

1. Swipe down the Status bar and tap **SETTINGS | WIRELESS & NETWORKS | More | Tethering & portable hot spot**.
2. Tap Wi-Fi hotspot slider to enable the hot spot function.
3. Tap Setup Wi-Fi hot spot to configure the settings as needed:
 - Network SSID: Enter a name to identify the wireless network created by the MTA-3101.
 - Security & password: To prevent your device from being accessed by unauthorized users, it is strongly recommended that you setup a password to protect your network.

Using the Rugged Handheld Device

When Wi-Fi hotspot is enabled, a Wi-Fi hotspot icon will appear in the **Notification Area**. You can swipe down the icon to see the connection information.

3.5 Enabling Bluetooth and Pairing with Bluetooth Device

1. Swipe down the Status bar and tap the BLUETOOTH tile to enable Bluetooth if it isn't enabled yet.
2. In the Quick Settings panel, tap and hold the BLUETOOTH tile to access the Bluetooth settings page.

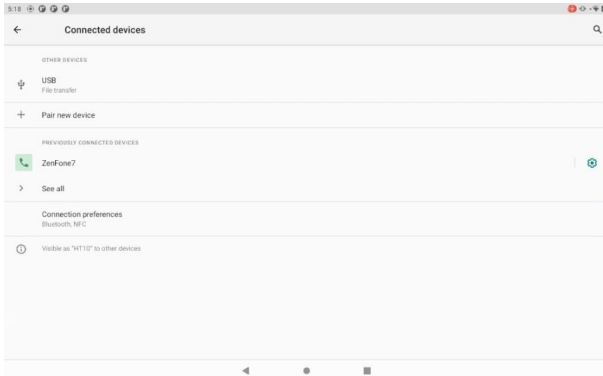

3. If the Bluetooth device you want to pair with is not displayed in the **AVAILABLE DEVICES** list, tap **SEARCH FOR DEVICES** in the upper right corner.

The MTA-3101 proceeds to scan for any Bluetooth device in range. Then it displays the names of the device(s) found.

If the MTA-3101 stops scanning before the other device becomes discoverable, tap **SEARCH FOR DEVICES** again.

Note: If the device to pair with isn't displayed after the scan, check if it is configured to be discoverable.

4. Tap the device you want to pair with. When the **Bluetooth pairing request** dialog box appears, tap **Pair**. The MTA-3101 will then send a connection request to the device you want to pair with.

On the device to pair with, a dialog box appears requesting to enter or verify the pairing code. The passkey entered or shown on the MTA-3101 and the Bluetooth device must be the same.

If you're prompted to enter a pin code, try entering 0000 or 1234 (the most common pin code), or look up in the documentation that came with the other Bluetooth device to learn its pin code.

Then the devices proceed to pair with each other.

3.5.1 Configuring Bluetooth Features to Use

A "Bluetooth profile" defines the features supported by a Bluetooth device. For two Bluetooth devices to share files with each other, they need to both support the right profile. Some Bluetooth devices have multiple profiles. A profile can provide the ability to transmit phone conversations, to play music in stereo, or to transfer files or other data. The operating system allows you to configure the profiles you want to use on the MTA-3101.

1. Swipe down the Status bar and tap the BLUETOOTH tile to enable Bluetooth if it isn't enabled yet.
2. In the Quick Settings panel, tap and hold the BLUETOOTH tile to access the Bluetooth settings page.
3. Tap the icon at the right of a paired device.

A "**Paired Bluetooth device**" page opens for that paired device.

4. Select or deselect a profile to use it.

3.5.2 Disconnect from a Bluetooth Device

To disconnect the MTA-3101 from a Bluetooth device:

1. Swipe down the Statusbar. In the **Quick Settings** panel, tap and hold the **BLUETOOTH** tile to access the **Bluetooth** settings page.
2. In the **PAIRED DEVICES** list, find the device to disconnect.
3. Tap the icon at the right of the device.

A "**Paired Bluetooth device**" page opens for that paired device.

4. Tap **Unpair**.

The selected device is unpaired and disconnected.

3.5.3 Additional Bluetooth Settings

From the Bluetooth settings page, tap the menu icon and a context menu opens providing the following options:

1. **Rename tablet:** Allows you to edit the Bluetooth name of the MTA-3101 that will be shown to others when they try to search for it.
2. **Visibility time out:** Allows you to configure the time of the visibility when you configure the MTA-3101 to be visible.
3. **Show received files:** Open the location where downloaded and uploaded Bluetooth files are stored.

3.6 Using the Location Feature

The MTA-3101 features positioning function to identify your location. It allows location-based Apps to collect and use your location information to provide location-related service. For example, a third-party App might want to pinpoint a vehicle's location so as to provide a more efficient route for the driver upon traffic congestion. For a location-based App, you can individually configure whether it is allowed to access to location services when the service is on.

Note: When the location service was disabled, the Apps also could not use that service.

3.6.1 Enabling/Disabling Location Service

To turn on or off location service, swipe down the **Status bar** to bring up the **Quick Settings** panel. then tap the **LOCATION** tile to turn on or off.

3.6.2 Enabling/Disabling Location Service

In addition to GPS satellite method, the MTA-3101 also supports Assisted GPS (A-GPS), a method using Wi-Fi and cellular networks to speed up startup positioning performance. According to the position mode, the battery drain and position accuracy varies.

To select a location position mode when the location service is on.

1. Swipe down the **Status bar** and tap the **LOCATION** tile to enable the location service if it isn't enabled yet.
2. In the **Quick Settings panel**, tap and hold the **LOCATION** tile to access the location settings page.
3. Tap **Mode** and select a mode:
 - **High accuracy:** This mode uses GPS, Wi-Fi and cellular networks to determine location. It drains the battery faster yet higher accuracy is

achieved compared to the other two modes. Select this mode if precise location matters to you.

- **Battery saving:** This mode uses Wi-Fi and cellular networks to determine your location. Select this mode if you need to extend the battery life.
- **Device only:** This mode determines your location using GPS only. Without using Wi-Fi and cellular networks to improve the startup process, it takes longer to determine the location.

3.7 Using Camera

The device is equipped with two cameras: a front-facing camera and a back-facing camera with LED flash. Using the native camera application that comes with the operation system, you can switch between the front and rear cameras and perform other camera operations.

To access the camera application, on the Home screen tap the camera icon:



The camera application then opens.

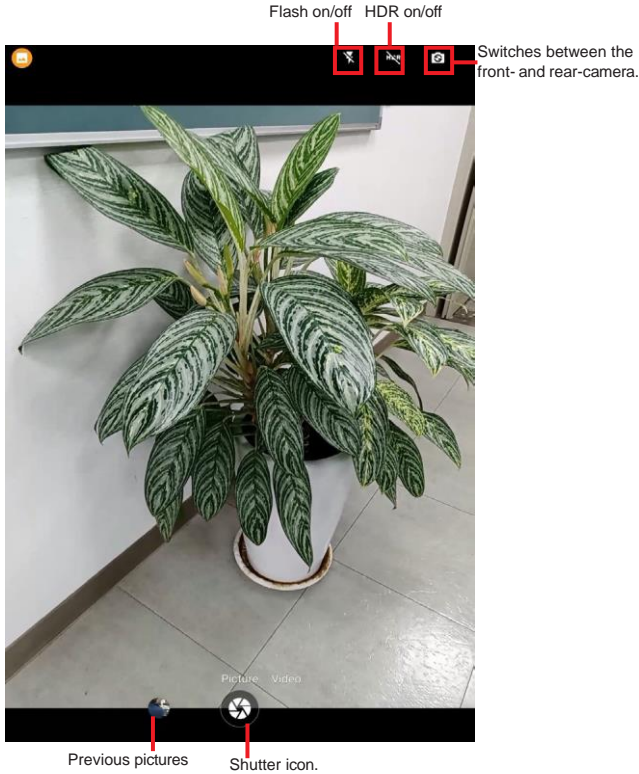

When taking a photo:

- To zoom in and out, place two fingers apart or together.
- When you frame your subject on the screen, the camera will Auto Focus on the center of the screen with a focus indicator. To manually make a focus, tap the target or area that you want to focus on.
- To take a photo, press the shutter icon.

When recording a video:

- To enable/disable the microphone, tap the Settings icon and then video icon.
- To start the recording, tap the Recorder icon and the timer starts.
- To stop the recording, tap the Recorder icon again.

3.8 Using the NFC Feature

Near Field Communication (NFC) is a short-range wireless communication technology that enables NFC-capable devices to exchange data such as contacts, photos, music, or web address over a short distance less than 4 centimeters.

The NFC detection area is at the back side of the MTA-3101. When you tap other NFC devices, tags, or readers, the NFC areas of both devices should be close to one another so that the connection can be established.

3.8.1 Enabling/Disabling NFC

To enable or disable the NFC function.

1. Swipe down the Status bar and tap Settings | Connection preferences | NFC |.
2. Tap the NFC slider to turn it on or off.

3.9 Using the Barcode Scanner

Depending on your models, your MTA-3101 might be equipped with 1D or 2D barcode scanner. This section will walk you through the basic operations. To get the information on supported barcode formats see.

Caution: The barcode scanner uses laser lights to scan barcodes. DO NOT stare into the laser beams or point the laser beam at anyone's eyes when the barcode scanner is in operation.



3.9.1 Scanning the Barcode

Generally a third-party barcode application will be used to process the data read by the scanner. This user manual will not cover these applications. The following steps serve as an example only to show the basic operation of the barcode scanner.

1. To scan a 2D barcode like QR code: Launch the web browser.
2. Point the scanner window at the bar code and press the Scan key. The scanner will project an aiming beam.
3. The scanned data is displayed in the text field, or an action is triggered according to the barcode scanner. .

3.9.2 Supported Barcode Formats

2D Model

| Type | Formats |
|------------|---|
| Linear | UPC/EAN/JAN, GS1 DataBar, Code 39, Code 128, Code 32, Code 93, Codabar/NW7, Interleaved 2 of 5, Code 2 of 5, Matrix 2 of 5, MSI, Telepen, Trioptic, China Post; |
| 2D Stacked | PDF417, MicroPDF417, GS1 Composite; |
| 2D Matrix | Aztec Code, Data Matrix, QR Code, Micro QR Code, MaxiCode, Han Xin Code; |
| Postal | Intelligent Mail Barcode, Postal-4i, Australian Post, British Post, Canadian Post, Japanese Post, Netherlands (KIX) Post, Postnet, Planet Code; |
| OCR Option | OCR-A, OCR-B, E13B (MICR) |